

# MINERTIA MOTOR T SERIES BULLETIN

SMALL SIZE DC SERVOMOTORS

FOR COMPUTER PERIPHERALS  
TYPE T01, T03, T06

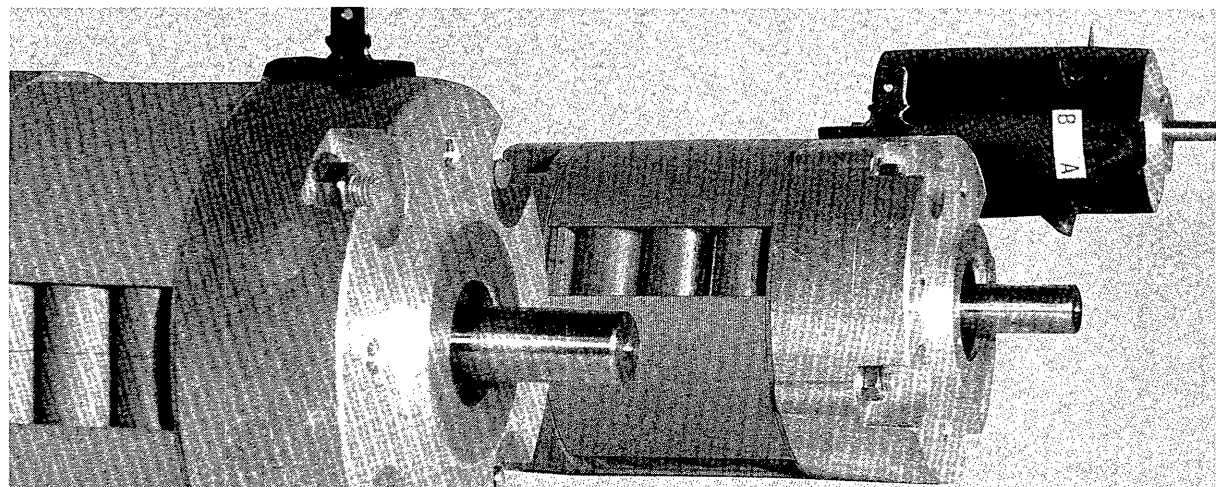

YASKAWA

TSE-C249-1C



## Designed to meet the Demands of Computer Peripherals

Creative design engineering and time-proven manufacturing technologies, blended with accumulated knowledge on computer peripherals, achieve light weight, low cost, and high reliability in the T Series.

Thermal time constants of ten minutes or more fully protect the motor from short term overloads. Nine standard models range from 1.5 to 3.35 inches in diameter, and their versatile functional ratings cover most application requirements.

## FEATURES

- Light weight, compact, high performance  
Alnico V field structure allows high power rate (kW/sec) per weight and size and weight reductions for many applications.
- Large load capacity  
Thermal time constants from 7 to 27 minutes protect motor from short term overloads.
- Smooth operation  
A special armature design greatly reduces cogging to provide smooth torque.
- Motors are available with optical encoders and analog tachometers.
- Construction suitable for application to the equipment.

## APPLICATIONS

- Head and carriage for serial printer
- Capstan and reel for magnetic tape
- Paper and ribbon feeding for line printer
- X-Y plotter
- Tape feeding for tape card punch
- Pick-up head drive for magnetic disc memories
- Recorder
- Small size general-purpose machinery

# Minertia Motor T Series

## Type T01, T03, T06

SAME AS  
T03L-KU2  
T03L-KU3

### RATINGS AND SPECIFICATIONS

Specifications	Motor Type	T01SB4	T01MB4	T01LB4	T03SB2	T03MB2	T03LB2	T06SB2	T06MB2	T06LB4	
Peak Rated Torque	oz·in	16.7	27.8	33.3	67.0	103.0	139.0	125.0	208.0	347.0	
Rated Torque	oz·in	8.3	12.5	13.9	36.1	55.6	69.4	61.1	93.1	138.9	
Torque Constant	oz·in/amp ±10%	4.9	7.4	8.1	10.7	10.1	16.9	12.9	17.0	24.4	
Armature Winding Resistance (at 25°C)	Ω ±10%	3.26	3.77	3.67	1.62	0.68	1.35	1.04	1.05	1.16	
Armature Inductance	mH	0.8	0.9	0.8	1.2	0.7	1.2	1.9	1.7	3.1	
Peak Current	A	3.8	4.0	4.5	6.8	10.9	8.7	10.4	12.8	15.0	
Voltage Constant	V/1000rpm ±10%	3.6	5.5	6.0	7.9	7.5	12.5	9.5	12.6	18.0	
Viscous Damping Coefficient	oz·in/1000rpm	0.27	0.50	0.71	0.81	1.14	1.25	1.67	1.74	2.78	
Friction Torque	oz·in	1.21	1.43	1.61	2.78	3.19	4.72	3.54	5.00	7.08	
Breakaway Torque	oz·in	1.32	1.53	1.71	2.92	3.33	4.86	4.31	5.28	7.36	
Inertia	oz·in·sec <sup>2</sup> × 10 <sup>-3</sup>	0.222	0.312	0.375	3.33	4.72	5.28	13.47	14.86	25.0	
Mechanical Time Constant	ms	4.1	2.9	2.8	6.7	4.4	3.5	12.0	7.6	6.9	
Electrical Time Constant	ms	0.2	0.2	0.2	0.7	1.0	0.9	1.8	1.6	2.7	
Power Rate	kW/sec	2.2	3.5	3.6	2.8	4.6	6.4	2.0	4.1	5.4	
Torque Inertia Ratio	rad/sec <sup>2</sup>	3.7 × 10 <sup>4</sup>	4.0 × 10 <sup>4</sup>	3.7 × 10 <sup>4</sup>	1.1 × 10 <sup>4</sup>	1.2 × 10 <sup>4</sup>	1.3 × 10 <sup>4</sup>	0.5 × 10 <sup>4</sup>	0.6 × 10 <sup>4</sup>	0.6 × 10 <sup>4</sup>	
Thermal Resistance	deg C/watt	5.20	4.70	4.60	2.55	2.50	2.45	2.35	1.85	1.80	
Thermal Time Constant	minutes	7	8	10	11	12	13	21	22	27	
Max Allowable Armature Temperature	°C	155	155	155	155	155	155	155	155	155	
Rated Speed	rpm	3000	2500	2000	2000	1500	1000	1300	1000	700	
Max Safe Operating Speed	rpm	4500	4500	4500	3000	3000	2000	2500	2000	3500	
Max No Load Speed	rpm	6000	6000	6000	6000	6000	6000	6000	6000	3500	
Cooling Required	cfm, in H <sub>2</sub> O	Totally-enclosed non-ventilated									

Note:

- Dielectric strength is 500VAC/min.
- Thermal characteristics are for motors mounted on a 4" × 4" × 1/8" heat sink for type T01, and a 10" × 10" × 1/4" heat sink for type T03 and T06.
- Armature windings and motor characteristics can be modified on special orders for high volume OEM applications.

### TORQUE-SPEED CHARACTERISTICS

Continuous duty zone  
Instantaneous duty zone  
Note: Size of heat sink —  
• 4" × 4" × 1/8" for type T01SB4, T01MB4 and T01LB4.  
• 10" × 10" × 1/4" for the rest of the types.

Type T01SB4

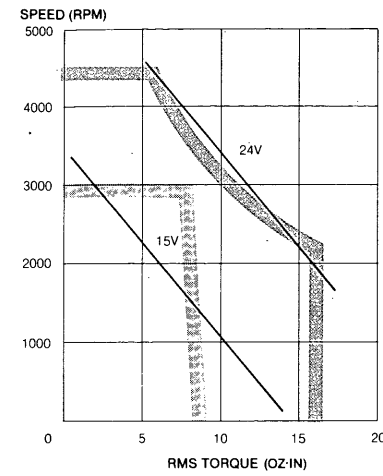

Type T01MB4

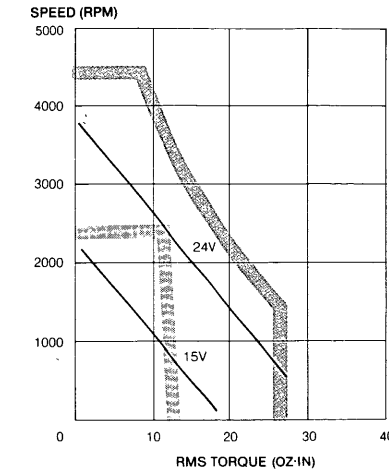

Type T01LB4

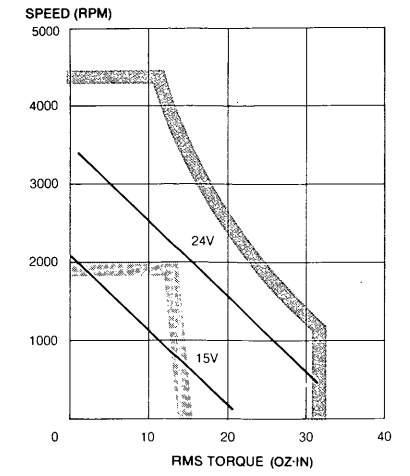

Type T03SB2

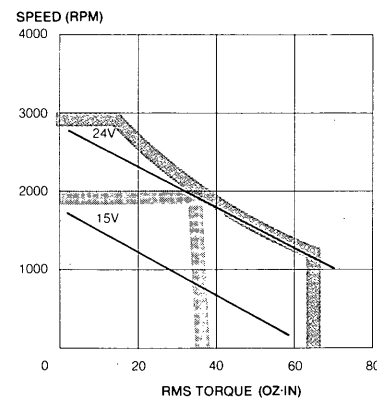

Type T03MB2

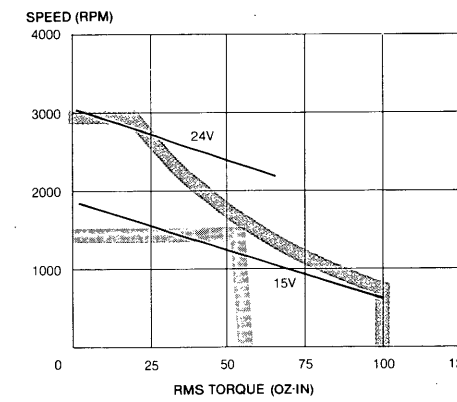

Type T03LB2

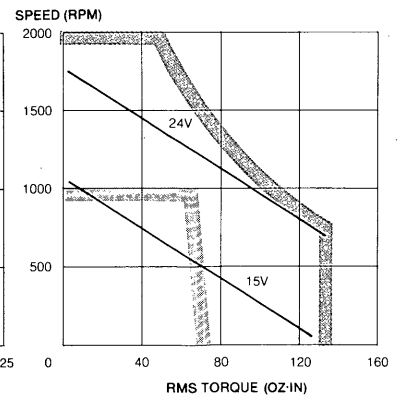

Type T06SB2

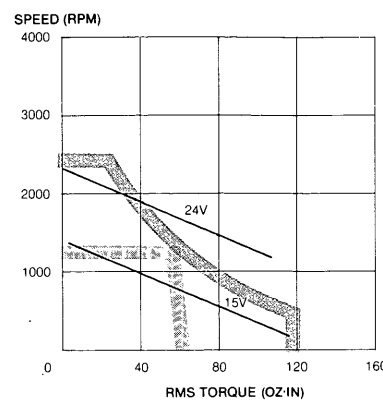

Type T06MB2

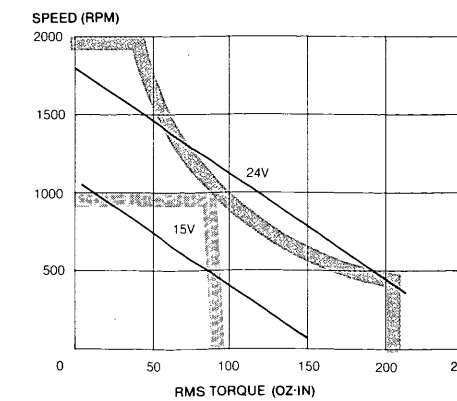

Type T06LB4

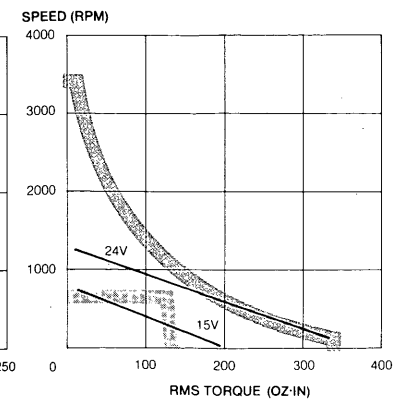

## STARTING AND OVERLOAD CHARACTERISTICS

Figures below show the allowable conduction time of armature current at starting and overload operation. This should be known before operation to avoid the damage to armature insulation due to overheat.

Cold-state curves are obtained at starting operation when armature temperature is equal to ambient temperature. Hot-state curves are obtained when armature temperature is saturated at the rated operation.

### Type T01

ALLOWABLE CONDUCTION TIME (SEC)

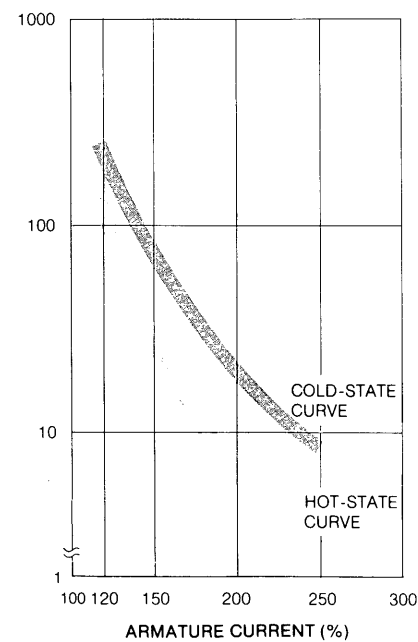

### Type T03

ALLOWABLE CONDUCTION TIME (SEC)

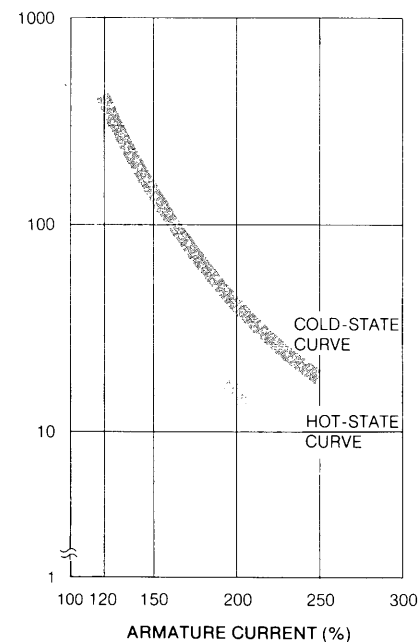

### Type T06

ALLOWABLE CONDUCTION TIME (SEC)

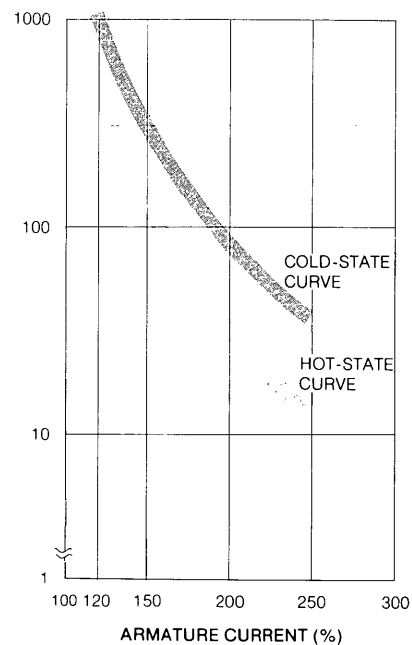

## MODULAR MINERTIA MOTORS T SERIES

### DC Tachometer Generator Characteristics

Characteristics	Tachometer Generator Type	G3VC	G7SC
Voltage Sensitivity*	(V/1000rpm) ± 10%	3	7
Ripple Voltage†	%P-P(at 1000rpm)	1.5	1.5
Ripple Frequency	cycles/rev.	13	13
Linearity‡, §	% (200-4000rpm)	1	1
Direction Deviation†, #	% (200-4000rpm)	1	1
Armature Inertia	oz-in-sec² × 10⁻³	0.21	0.21
	g-cm-sec² × 10⁻³	15.3	15.3
Armature Resistance	Ω (25°C)	30	150
Stability (Temperature Coefficient)	%/°C	-0.05	-0.05
Effective Speed Range	rpm	200-4000	200-4000
Max Safety Speed	rpm	5000	5000
Min Load Impedance	kΩ	5.1	5.1
Insulation Resistance with a 500V Megger	MΩ	10	10
Withstand Voltage for 1 Minute	VAC	500	500
Temperature	°C	0-60	0-60
Humidity (without a Drop of Water)	%	20-80	20-80
Rated Operating Life	Hours	5000	5000

Note:

1. Connecting OUTPUT terminal with resistance, total load impedance may exceed 5.1 kΩ.
2. In case of motor drive source with no transformer, tach-generator winding to be isolated from motor drive source.

\*Terminal Open

†Filter

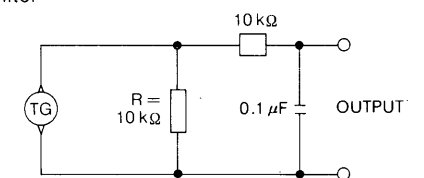

‡Linearity

$$\text{Linearity at } N_k \text{ (rpm)} = \frac{|E_k - N_k \cdot E_a|}{N_k \cdot E_a} \times 100\%$$

$$E_a = \frac{E_1 + E_2 + \dots + E_n}{N_1 + N_2 + \dots + N_n}$$

#Direction Deviation

$$\text{Direction Deviation} = \frac{|E_{cw} - E_{ccw}|}{E_{cw}} \times 100\%$$

**DIMENSIONS** in inches

Minertia Motors T Series without Tachometer Generator

**Drawing 1**

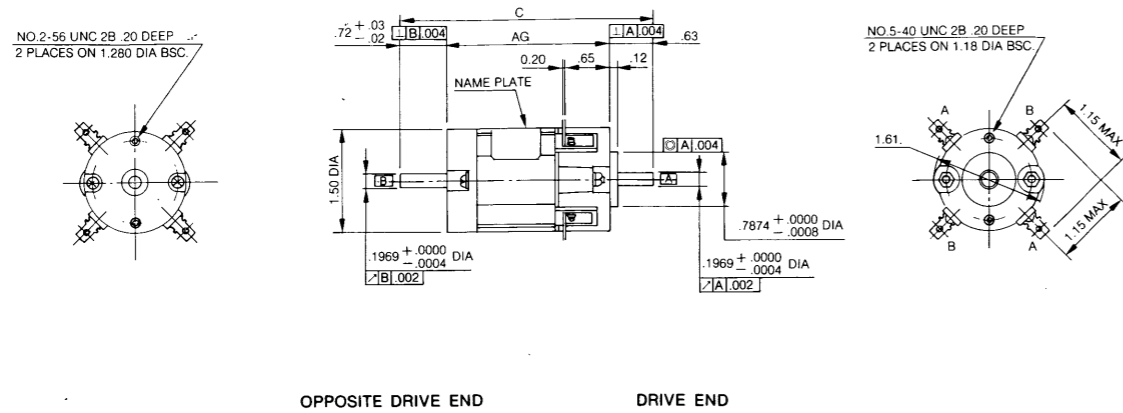

**Drawing 2**

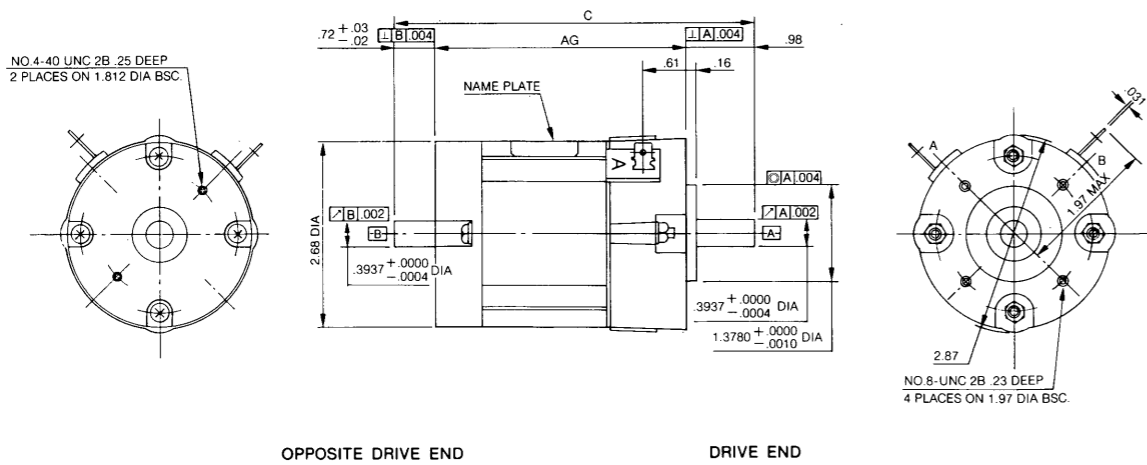

**Terminal Detail**

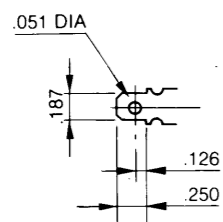

FASTON 187 SERIES TAB  
FOR TYPE T01

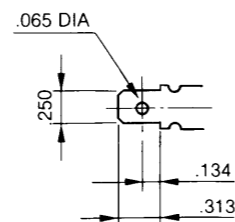

FASTON 250 SERIES TAB  
FOR TYPE T03, T06

**Drawing 3**

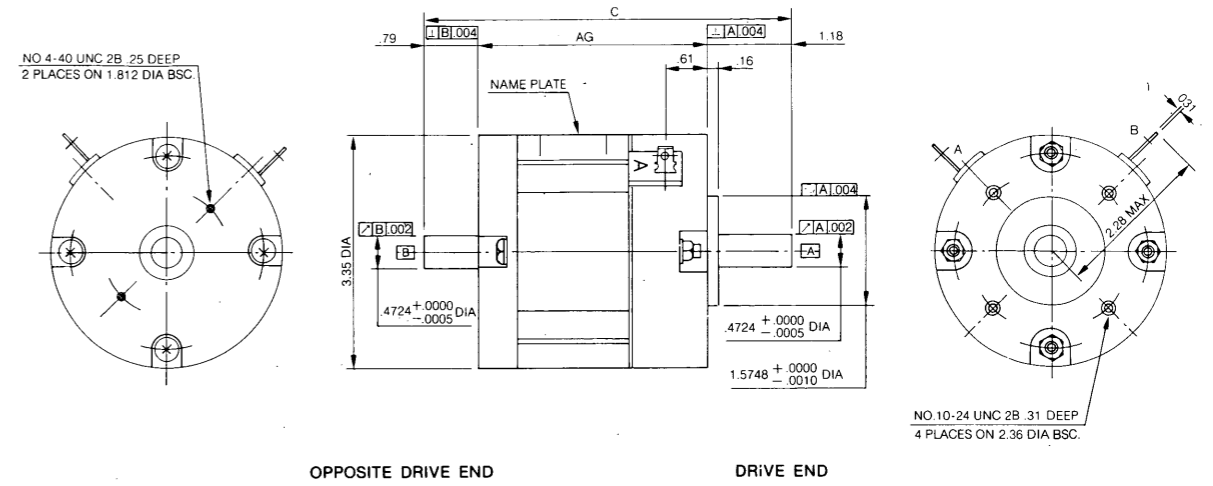

**Drawing 4**

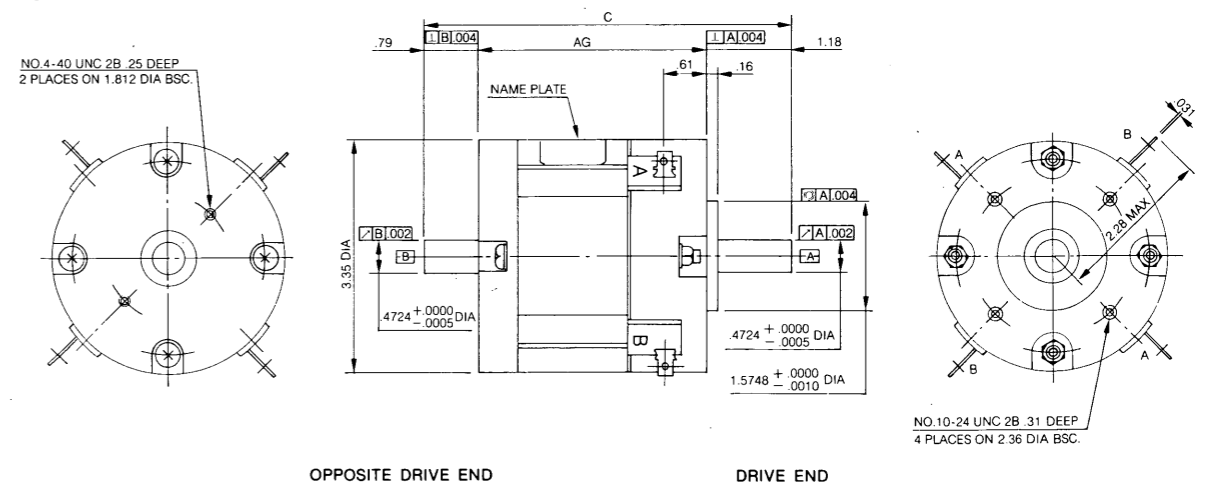

Motor Type	T01SB4	T01MB4	T01LB4	T03SB2	T03MB2	T03LB2	T06SB2	T06MB2	T06LB4
Drawing	1	1	1	2	2	2	3	3	4
Dimensions ins.	C	3.34	3.71	4.09	4.77	5.32	5.87	5.04	5.32
	AG	1.99	2.36	2.74	3.07	3.62	4.17	3.07	3.35
Approx Weight lbs	0.49	0.62	0.79	2.4	2.9	3.3	3.5	3.7	5.5

# Minertia Motor T Series

## Type T01, T03, T06

### DIMENSIONS (Cont'd) in inches

#### Minertia Motors T Series with Tachometer Generator

Drawing 5

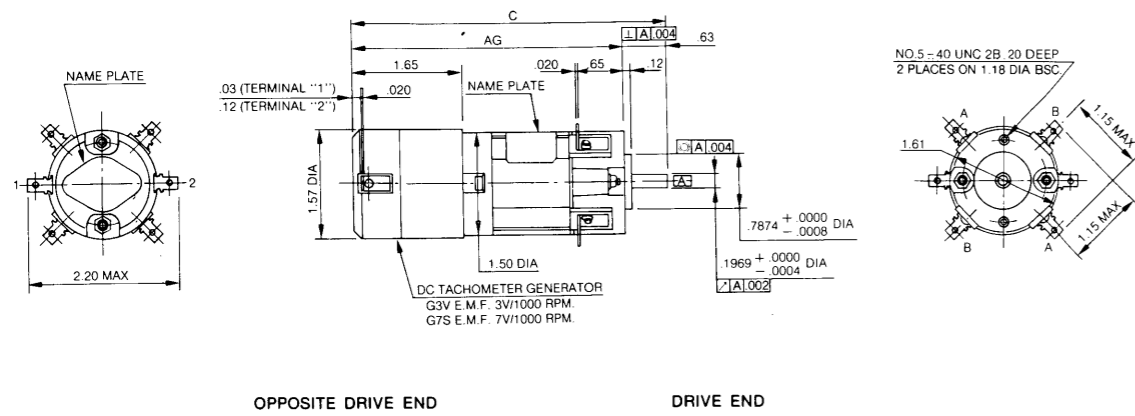

Drawing 7

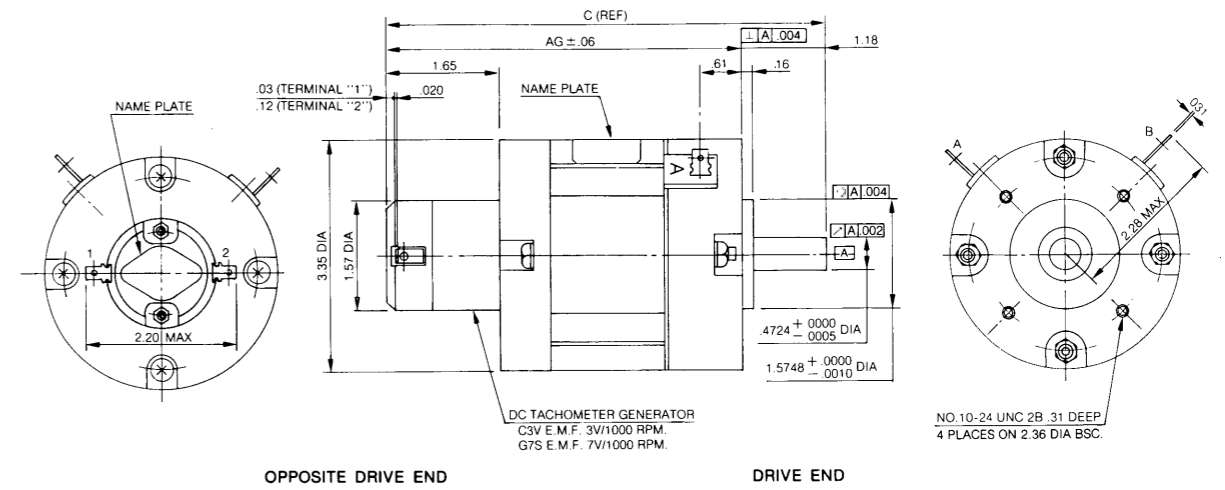

Drawing 6

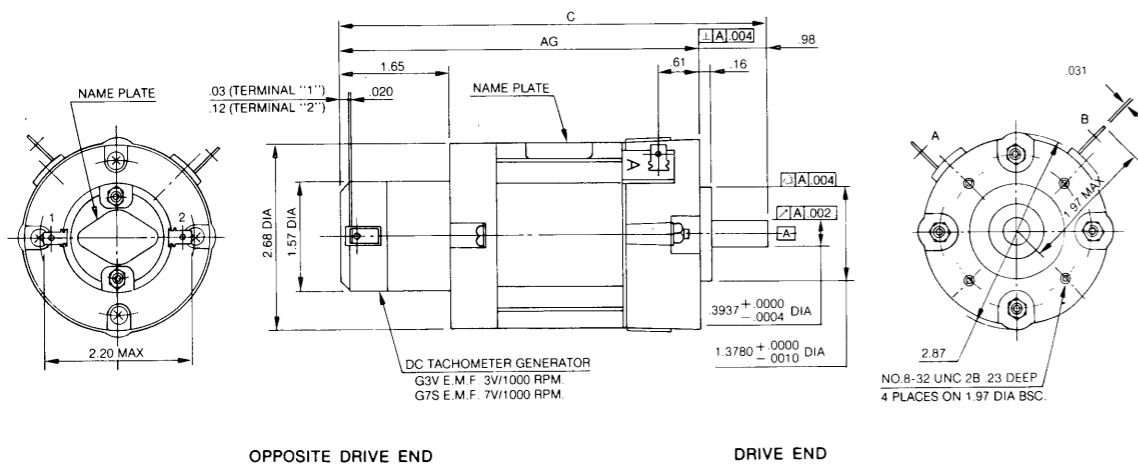

Drawing 8

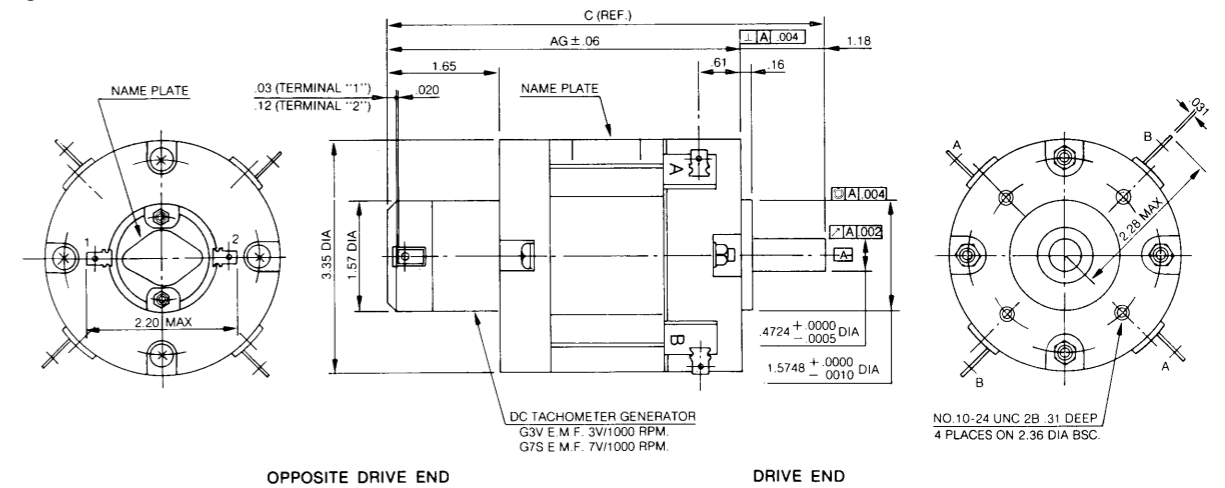

#### Terminal Detail

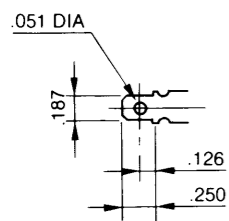

FASTON 187 SERIES TAB  
FOR TYPE T01

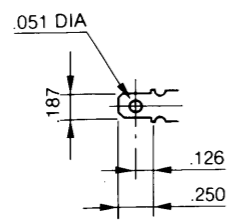

FASTON 187 SERIES TAB  
FOR TACH-GENERATOR

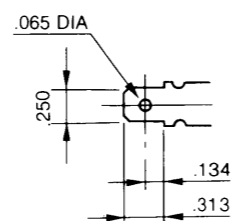

FASTON 250 SERIES TAB  
FOR TYPE T03, T06

Motor Type	T01SB4/G3V T01SB4/G7S	T01MB4/G3V T01MB4/G7S	T01LB4/G3V T01LB4/G7S	T03SB2/G3V T03SB2/G7S	T03MB2/G3V T03MB2/G7S	T03LB2/G3V T03LB2/G7S	T06SB2/G3V T06SB2/G7S	T06MB2/G3V T06MB2/G7S	T06LB4/G3V T06LB4/G7S	
Drawing	5	5	5	6	6	6	7	7	8	
Dimensions ins.	C	4.27	4.65	5.02	5.74	6.29	6.85	5.88	6.16	6.98
	AG	3.64	4.02	4.39	4.76	5.31	5.87	4.70	4.98	5.80
Approx Weight lbs	0.93	1.06	1.23	2.84	3.34	3.74	3.94	4.14	5.94	

Note:

- All dimensions in inches, 2-decimal tolerance  $\pm .03$ , 3-decimal tolerance  $\pm .010$ .
- Terminal "A" (Pos.) and "B" (Neg.), CW rotation, when viewed from drive end (shaft A).
- Terminal of tachometer generator "1" (Pos.) and "2" (Neg.), CW rotation, when viewed from drive end (shaft A).

## ALLOWABLE RADIAL AND THRUST LOAD

Motor Type	Rated Speed rpm	L in.	Allowable Radial Load Fr Max lbs	Allowable Thrust Load Fa Max lbs
T01SB4	3000	.63	4.4	4.4
T01MB4	2500	.63	4.4	4.4
T01LB4	2000	.63	4.4	4.4
T03SB2	2000	.98	17.6	9.9
T03MB2	1500	.98	17.6	14.3
T03LB2	1000	.98	17.6	20.9
T06SB2	1300	1.18	32.0	15.4
T06MB2	1000	1.18	32.0	20.9
T06LB4	700	1.18	32.0	32.0

**Note:**

1. The value of allowable radial load should be measured at the end of shaft "L" shown in figure below. It includes radial load generated by motor.

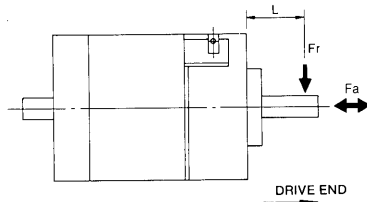

2. Allowable thrust load is based on the assumption that motor is driven at rated speed and has 10,000 hours of bearing life.

# MINERTIA MOTOR T SERIES BULLETIN

**TOKYO OFFICE** Ohtemachi Bldg, 1-6-1 Ohtemachi, Chiyoda-ku, Tokyo, 100 Japan  
Phone (03) 3284-9111 Telex YASKAWA J33530 Fax (03) 3284-9034

**YASKAWA ELECTRIC AMERICA, INC.**

**Chicago-Corporate Headquarters** 2942 MacArthur Blvd. Northbrook, IL 60062-2028, U.S.A.  
Phone (708) 291-2340 Fax (708) 498-2430

**Chicago-Technical Center** 3160 MacArthur Blvd. Northbrook, IL 60062-1917, U.S.A.  
Phone (708) 291-0411 Fax (708) 291-1018

**MOTOMAN INC.**

805 Liberty Lane West Carrollton, OH 45449, U.S.A.  
Phone (513) 847-6200 Fax (513) 847-6277

**YASKAWA ELÉTRICO DO BRASIL COMÉRCIO LTDA.**

Rua Conde Do Pinhal 8-5, Andar Sala 51 CEP 01501-São Paulo-SP, Brasil  
Phone (011) 35-1911 Fax (011) 37-7375

**YASKAWA ELECTRIC EUROPE GmbH**

Am Kronberger Hang 2, 65824 Schwalbach, Germany  
Phone (49) 6196-569-300 Fax (49) 6196-888-301

**Motoman Robotics AB**

Box 130 S-38500, Torsås, Sweden  
Phone 0486-10575 Fax 0486-11410

**Motoman Robotec GmbH**

Kammerfeldstraße 1, 85391 Allershausen, Germany  
Phone 08166-900 Fax 08166-9039

**YASKAWA ELECTRIC UK LTD.**

3 Drum Mains Park Orchardton Woods Cumbernauld, Scotland, G68 9LD U.K.  
Phone (1236)735000 Fax (1236)458182

**YASKAWA ELECTRIC KOREA CORPORATION**

Paik Nam Bldg, 901 188-3, 1-Ga Euljiro, Joong-Gu Seoul, Korea  
Phone (02)776-7844 Fax (02)753-2639

**YASKAWA ELECTRIC (SINGAPORE) PTE. LTD.**

**Head Office** : CPF Bldg, 79 Robinson Road # 13-05, Singapore 0106, SINGAPORE  
Phone 221-7530 Telex (87) 24890 YASKAWA RS Fax 224-5854

**Service Center** : 221 Henderson Road, # 07-20 Henderson Building Singapore 0315, SINGAPORE  
Phone 276-7407 Fax 276-7406

**YATEC ENGINEERING CORPORATION**

Shen Hsiang Tang Sung Chiang Building 10F 146 Sung Chiang Road, Taipei, Taiwan  
Phone (02) 563-0010 Fax (02) 567-4677

**SHANGHAI OFFICE** Room No. 8B Wan Zhong Building 1303 Yan An Road (West), Shanghai 200050, CHINA  
Phone (86) 212-1015 Fax (86) 212-1015

**TAIPEI OFFICE** Shen Hsiang Tang Sung Chiang Building 10F 146 Sung Chiang Road, Taipei, Taiwan  
Phone (02) 563-0010 Fax (02) 567-4677



YASKAWA

YASKAWA ELECTRIC CORPORATION

TSE-C249-1C